

IHOS

INTELLIGENT AUDIO

www.i-hos.eu

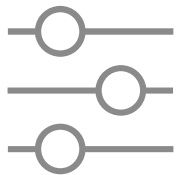
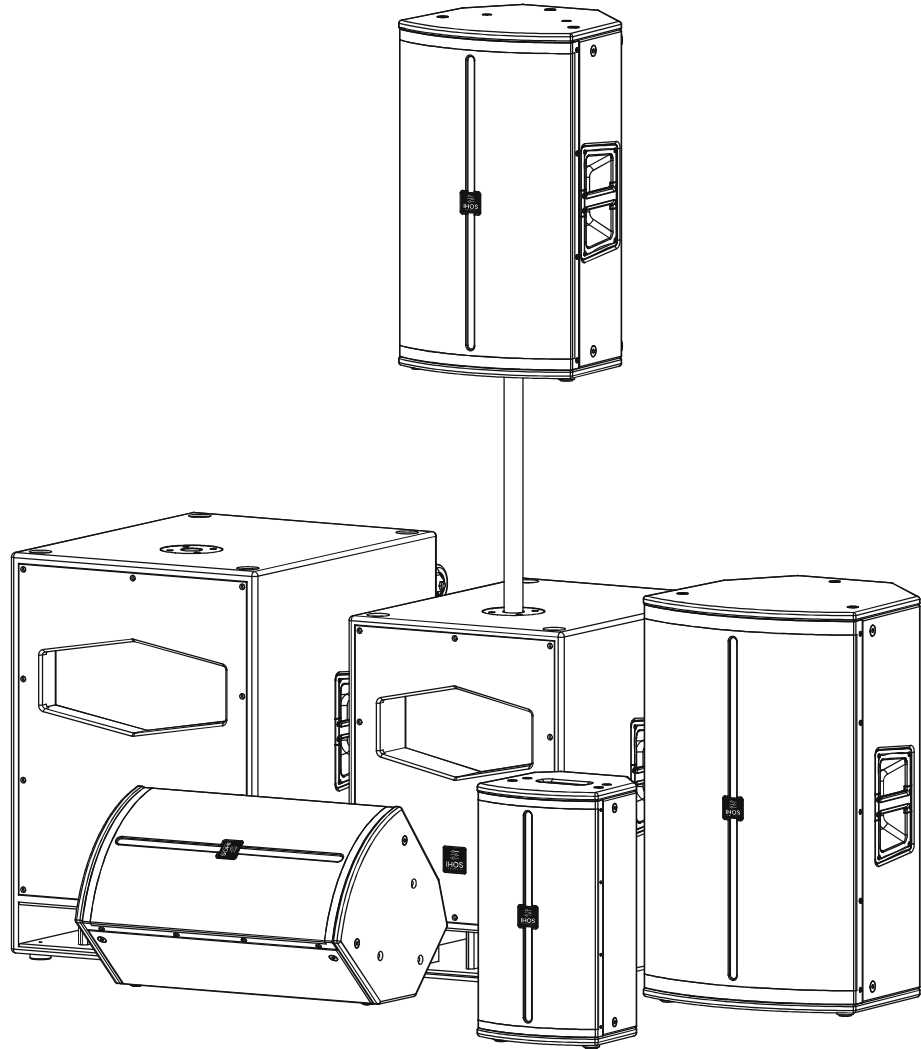

IHOS

INTELLIGENT AUDIO

Professional Audio

IOS 10A/12A/15A DSP
IOS 15A/18A SUB





USER MANUAL

CONTENTS











USING THE UNIT SAFELY	3
PRODUCTS AND ACCESSORIES	6
IOS 10A DSP CONTROLS AND FUNCTIONS.....	8
IOS 12A/15A DSP CONTROLS AND FUNCTIONS	10
IOS 15A/18A SUB CONTROLS AND FUNCTIONS	12
TECHNICAL SPECIFICATIONS	14
INSTALLATION.....	15
IOS 10A/12A/15A DSP FUNCTION INSTURCTION	16
IOS 15A /18A SUB FUNCTION INSTURCTION.....	18
SUPPORT AND TROUBLESHOOT ING	19

USING THE UNIT SAFELY

INSTRUCTIONS FOR THE PREVENTION OF FIRE, ELECTRIC SHOCK, OR INJURY TO PERSONS















About WARNING and CAUTION Notices		About the Symbols	
 WARNING	Used for instructions intended to alert the user to the risk of death or severe injury should the unit be used improperly.		This symbol alerts the user to important instructions or warnings.
 CAUTION	Used for instructions intended to alert the user to the risk of injury or material damage should the unit be used improperly.		This symbol alerts the user to items that must never be carried out (are forbidden).



ALWAYS OBSERVE THE FOLLOWING

WARNING		WARNING	
	Before using this unit, make sure to read the instructions below, and the Owner's Manual.		Use only the attached power-supply cord. Also, the supplied power cord must not be used with any other device.
	Do not open (or modify in any way) the unit or its AC adaptor.		Do not excessively twist or bend the power cord, nor place heavy objects on it. Doing so can damage the cord, producing severed elements and short circuits. Damaged cords are fire and shock hazards.
	Do not attempt to repair the unit, or replace parts within it(except when this manual provides specific instructions directing you to do so). Refer all servicing to your retailer or the nearest authorized Service Center.		This unit, either alone or in combination with an amplifier and headphones or speakers, may be capable of producing sound levels that could cause permanent hearing loss. Do not operate for a long period of time at a high volume level, or at a level that is uncomfortable. If you experience any hearing loss or ringing in the ears, you should immediately stop using the unit, and consult an audiologist.
	Never use or store the unit in places that are: <ul style="list-style-type: none"> ●Subject to temperature extremes(e.g., direct sunlight in an enclosed vehicle, near a heating duct, on top of heat-generating equipment); or are ●Damp and humid(e.g., baths, washrooms, on wet floors); or are ●Exposed to rain; or are ●Dusty; or are ●Subject to high levels of vibration. 		Do not allow any objects (e.g., flammable material, coins, pins); or liquids of any kind (water, soft drinks, etc.) to penetrate the unit.
	Make sure you always have the unit placed so it is level and sure to remain stable. Never place it on stands that could wobble, or on inclined surfaces.		Immediately turn the power off, remove the AC adaptor from the outlet, and request servicing by your retailer or the nearest authorized Service Center when:

	Be sure to use only the AC adaptor supplied with the unit. Also, make sure the line voltage at the installation matches the input voltage specified on the AC adaptor's body.		<p>The AC adaptor, the power-supply cord, or the plug has been damaged; or</p> <p>If smoke or unusual odor occurs</p> <p>Objects have fallen into, or liquid has been spilled onto the unit; or</p> <p>The unit has been exposed to rain (or otherwise has become wet); or</p> <p>The unit does not appear to operate normally or exhibits a marked change in performance.</p>
---	---	--	--

USING THE UNIT SAFELY

WARNING		CAUTION	
	Protect the unit from strong impact. (Do not drop it!)		Try to prevent cords and cables from becoming entangled. Also, all cords and cables should be placed so they are out of the reach of children.
	Do not force the unit's power-supply cord to share an outlet with an unreasonable number of other devices. Be especially careful when using extension cords-the total power used by all devices you have connected to the extension cord's outlet must never exceed the power rating (watts/amperes) for the extension cord. Excessive loads can cause the insulation on the cord to heat up and eventually melt through.		Never climb on top of, nor place heavy objects on the unit.
	Before using the unit in a foreign country, consult with your retailer or the nearest authorized Service Center.		Never handle the AC adaptor or its plugs with wet hands when plugging into, or unplugging from, an outlet or this unit.
	Batteries must never be recharged, heated, taken apart, or thrown into fire or water.		Before moving the unit, disconnect the AC adaptor and all cords coming from external devices.
	Only switching off the unit and unplugging from an outlet, the unit is powered off completely.		Before cleaning the unit, turn off the power and unplug the AC adaptor from the outlet.
	The unit and the AC adaptor should be located so their location or position does not interfere with their proper ventilation.		Whenever you suspect the possibility of lightning in your area, disconnect the AC adaptor from the outlet.
	Always grasp only the plug on the AC adaptor cord when plugging into, or unplugging from, an outlet or this unit.		<p>If used improperly, batteries may explode or leak and cause damage or injury. In the interest of safety, please read and observe the following precautions.</p> <ul style="list-style-type: none"> ● Carefully follow the installation instructions for batteries, and make sure you observe the correct polarity. ● Avoid using new batteries together with used ones. ● If a battery has leaked, use a soft piece of cloth or paper towel to wipe all remnants of the discharge from the battery compartment. Then install new batteries. To avoid inflammation of the skin, make sure that none of the battery discharge gets onto your hands or skin. Exercise the utmost caution so that none of the discharge gets near your eyes. Immediately rinse the affected area with running water if any of the discharge has entered the eyes. ● Never keep batteries together with metallic objects such as ballpoint pens, necklaces, hairpins, etc. ● Dispose of the waste battery according to national or local regulations regarding hazardous waste.

	<p>At regular intervals, you should unplug the AC adaptor and clean it by using a dry cloth to wipe all dust and other accumulations away from its prongs. Also, disconnect the power plug from the power outlet whenever the unit is to remain unused for an extended period of time. Any accumulation of dust between the power plug and the power outlet can result in poor insulation and lead to fire.</p>		<p>Should you remove screws, keep them in a safe place out of children's reach, so there is no chance of them being swallowed accidentally.</p>
			<p>Shock hazardous voltages and currents are present inside the enclosure. Do not remove and replace the speaker grill and speaker by any means.</p>

USING THE UNIT SAFELY

IMPORTANT NOTES

Power Supply: Use of Batteries

- Do not connect this unit to same electrical outlet that is being used by an electrical appliance that is controlled by an inverter (such as a refrigerator, washing machine, microwave oven, or air conditioner), or that contains a motor. Depending on the way in which the electrical appliance is used, power supply noise may cause this unit to malfunction or may produce audible noise. If it is not practical to use a separate electrical outlet, connect a power supply noise filter between this unit and the electrical outlet.
- The AC adaptor will begin to generate heat after long hours of consecutive use. This is normal, and is not a cause for concern.
- When installing or replacing batteries, always turn off the power on this unit and disconnect any other devices you may have connected. This way, you can prevent malfunction and /or damage to speakers or other devices.
- Use only suitable rechargeable batteries of the same size and type. Make sure the polarity is correct. Or it may cause this unit to malfunction.
- Please charge the battery as soon as you can when in low energy. The battery's storage capacity goes down if not using it for a long time.

Note: Please charge the battery once a month regularly if not using it for long period.

Placement

- Using the unit near power amplifier (or other equipment containing large power transformers) may induce hum. To alleviate the problem, change the orientation of this unit; or move it farther away from the source of interference.
- This device may interfere with radio and television reception. Do not use this device in the vicinity of such receivers.
- Noise may be produced if wireless communications devices, such as cell phones, are operated in the vicinity of this unit. Such noise could occur when receiving or initiating a call, or while conversing. Should you experience such problems, you should relocate such wireless devices so they are at a greater distance from this unit, or switch them off.
- Do not expose the unit to direct sunlight, place it near devices that radiate heat, leave it inside an enclosed vehicle, or otherwise subject it to temperature extremes. Also, do not allow lighting devices that normally are used while their light source is very close to the unit (such as a piano light), or powerful spotlights to shine upon the same area of the unit for extended periods of time. Excessive heat can deform or discolor the unit.

IMPORTANT NOTES

- When moved from one location to another where the temperature and /or humidity is very different, water droplets (condensation) may form inside the unit, you must allow it to stand for several hours, until the condensation has completely evaporated.
- Do not allow rubber, vinyl, or similar materials to remain on the unit for long periods of time. Such objects can discolor or otherwise harmfully affect the finish.
- Do not paste stickers, decals, or the like to this instrument. Peeling such matter off the instrument may damage the exterior finish.

Maintenance

- For everyday cleaning wipe the unit with a soft, dry cloth or one that has been slightly dampened with water. To remove stubborn dirt, use a cloth impregnated with a mild, non-abrasive detergent. Afterwards, be sure to wipe the unit thoroughly with a soft, dry cloth.
- Never use benzine, thinners, alcohol or solvents of any kind, to avoid the possibility of discoloration and/or deformation.

Additional Precautions

- Use a reasonable amount of care when using the unit's buttons, sliders, or other controls; and when using its jacks and connectors. Rough handling can lead to malfunctions.
- When connecting/disconnecting all cables, grasp the connector itself-never pull on the cable. This way you will avoid causing shorts, or damage to the cable's internal elements.
- To avoid disturbing your neighbors, try to keep the unit's volume at reasonable levels (especially when it is late at night or near specific places like schools or hospitals).
- When you need to transport the unit, package it in the box (including padding) that it came in, if possible. Otherwise, you will need to use equivalent packaging materials.
- Some connection cables contain resistors. Do not use cables that incorporate resistors for connecting to this unit. The use of such cables can cause the sound level to be extremely low, or impossible to hear. For information on cable specifications, contact the manufacturer of the cable.

PRODUCTS AND ACCESSORIES

PRODUCTS AND ACCESSORIES

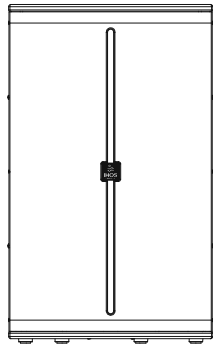

IOS 15A DSP

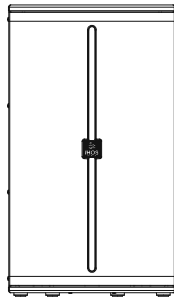

IOS 12A DSP



IOS 10A DSP



Manual
Power Cable

Manual
Power Cable

Manual
Power Cable

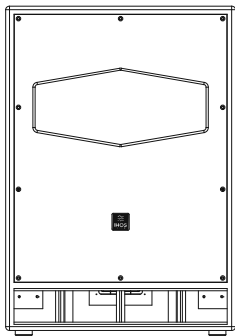

IOS 18A SUB

Manual
Power Cable

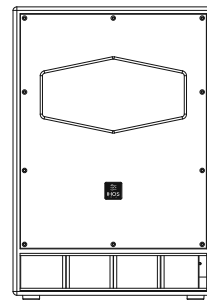

IOS 15A SUB

Manual
Power Cable



IOS 15A/18A SUB Optional accessories

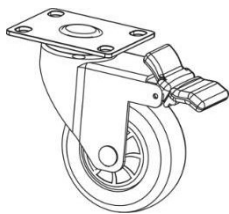

Wheel *4pcs

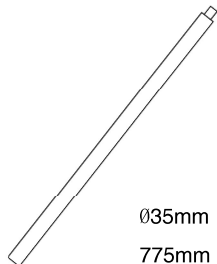

Ø35mm Pole
775mm Length

IOS 10A/12A/15A DSP Optional accessories

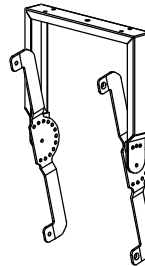

Wall Bracket 1



Wall Bracket 2

IOS 10A DSP CONTROLS AND FUNCTIONS

CONTROL PANEL

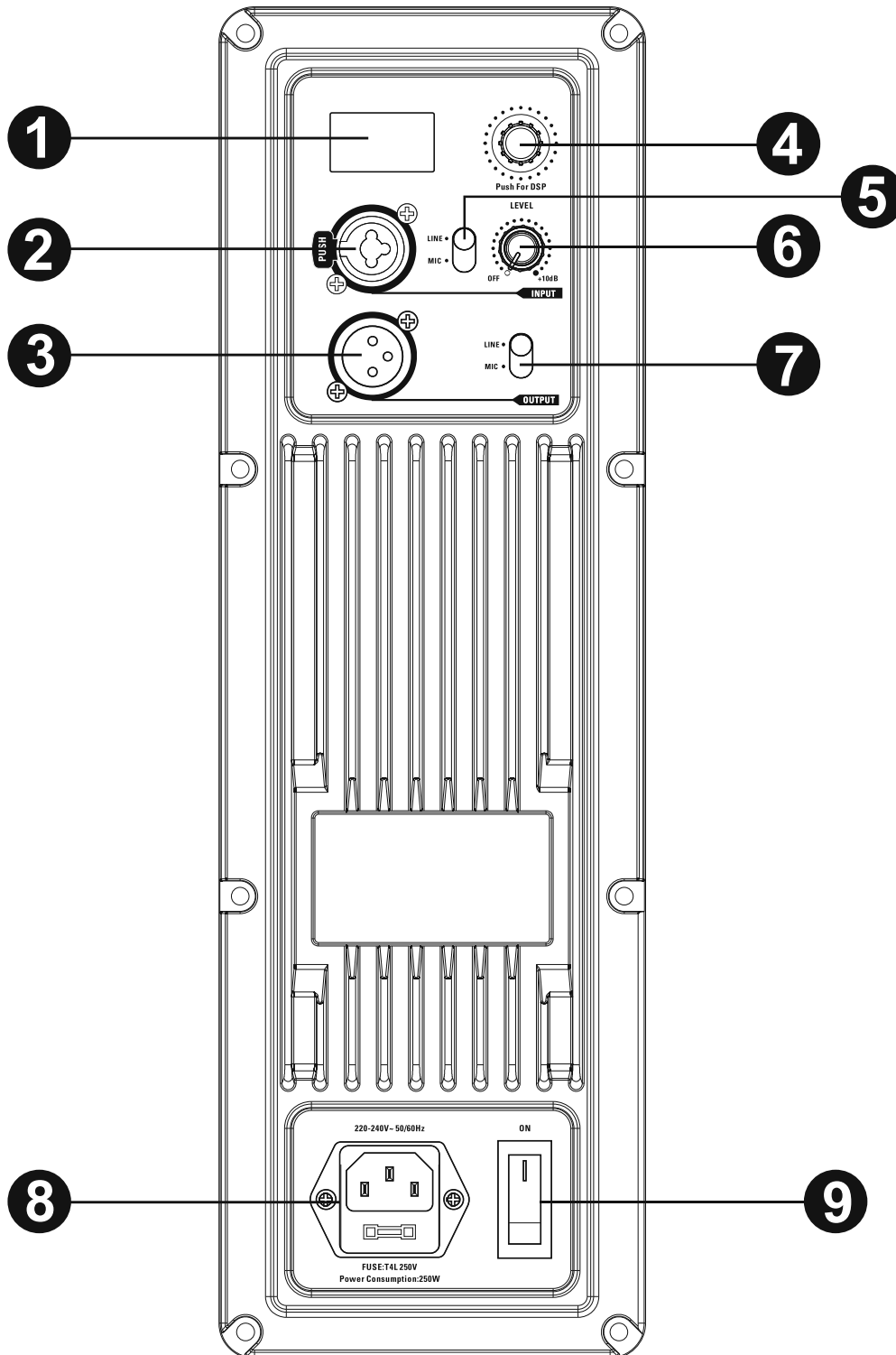

IOS 10A DSP CONTROLS AND FUNCTIONS

PANEL FUNCTIONS INSTRUCTIONS

1. LCD DISPLAY

The display shows the current DSP status(current preset, digital signal attenuation, input level) and it is used to access the DSP parameters(see DSP SETTINGS for detailed instructions)

2. COMBO XLR-JACK input

This is a female combo connector, which accepts a XLR or JACK plug from almost type of equipment with a balanced or unbalanced inputs.

Note: whenever possible, use always balanced cables.
Unbalanced lines may also be used but may result in noise over long cable runs.

The XLR input is wired as follows:

pin 1=GND

pin 2=+positive or hot

pin 3=-negative or cold

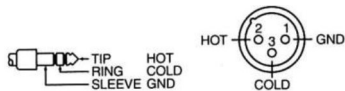

Balanced JACK input is wired as follows :

Tip=+positive or hot

Ring=-negative or cold

Sleeve=GND

3. XLR output

The XLR connector can connect it to input of another powered active speaker or amplifier, output signal is controlled by input channel volume or not.

4. DSP Edit button

Push and turn this knob to edit the DSP parameters(see DSP SETTINGS for detailed instruction).

5. LINE/MIC input switch

This switch sets the sensitivity of the respective channel for microphone or line level equipment.

6. Input signal volume control

This knob control input signal volume, turn left is min volume, turn right is max volume.

7. LINK/MIX switch

The switch set to LINK, another connected speaker volume wasn't controlled by current device. The switch set to MIX, another connected speaker volume was controlled by current device.

PANEL FUNCTIONS INSTRUCTIONS

8. AC socket

Here's where you plug in your speaker's mains supply cord, you should always use the mains cord supplied with the speaker. 220~240V-50/60Hz,T3.15AL/250V fuse.

Be sure your speaker is turned off before you plug the mains supply cord into an electrical outlet.

9.Power switch

Speaker is "ON" when the switch is in the "ON" position.

Note: when you shut down your equipment, turn off the speakers first. When powering up, turn on the speakers last.

IOS 12A/15A DSP CONTROLS AND FUNCTIONS

PANEL FUNCTIONS INSTRUCTIONS

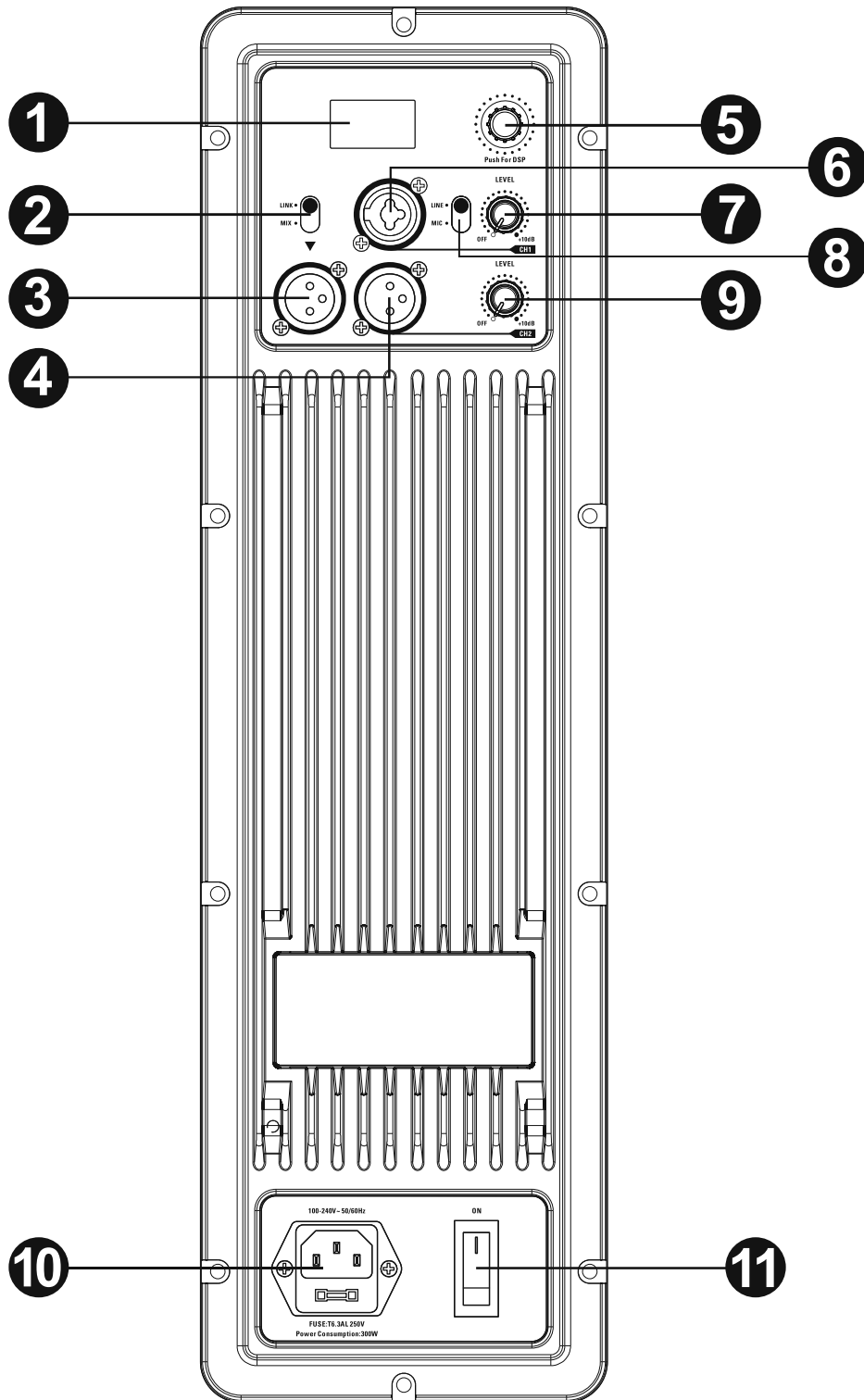

IOS 12A/15A DSP CONTROLS AND FUNCTIONS

PANEL FUNCTIONS INSTRUCTIONS

1. LCD DISPLAY

The display shows the current DSP status(current preset, digital signal attenuation, input level) and it is used to access the DSP parameters(see DSP SETTINGS for detailed instructions)

2. LINK/MIX switch

The switch set to LINK, another connected speaker volume wasn't controlled by current device. The switch set to MIX, another connected speaker volume was controlled by current device.

3. XLR output

The XLR connector can connect it to input of another powered active speaker or amplifier, output signal is controlled by input channel volume or not.

4. CH2 XLR input

XLR balance input,

5. DSP Edit button

Push and turn this knob to edit the DSP parameters(see DSP SETTINGS for detailed instruction).

6. CH1 COMBO XLR-JACK input

This is a female combo connector, which accepts a XLR or JACK plug from almost type of equipment with a balanced or unbalanced inputs.

Note: whenever possible, use always balanced cables.
Unbalanced lines may also be used but may result in noise over long cable runs.

The XLR input is wired as follows:

pin 1=GND

pin 2=+positive or hot

pin 3=-negative or cold

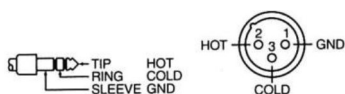

Balanced JACK input is wired as follows:

Tip=+positive or hot

Ring=-negative or cold

Sleeve=GND

7. CH1 Input signal volume control

This knob control input signal volume, turn left is min volume, turn right is max volume.

PANEL FUNCTIONS INSTRUCTIONS

8.CH1 LINE/MIC input switch

This switch sets the sensitivity of the respective channel for microphone or line level equipment.

9. CH2 Input signal volume control

This knob control input signal volume, turn left is min volume, turn right is max volume.

10. AC socket

Here's where you plug in your speaker's mains supply cord, you should always use the mains cord supplied with the speaker. 100~240V-50/60Hz,T6.3AL/250V fuse.

Be sure your speaker is turned off before you plug the mains supply cord into an electrical outlet.

11.Power switch

Speaker is "ON" when the switch is in the "ON" position.

Note: when you shut down your equipment, turn off the speakers first. When powering up, turn on the speakers last.

IOS 15A/18A SUB CONTROLS AND FUNCTIONS

PANEL FUNCTIONS INSTRUCTIONS

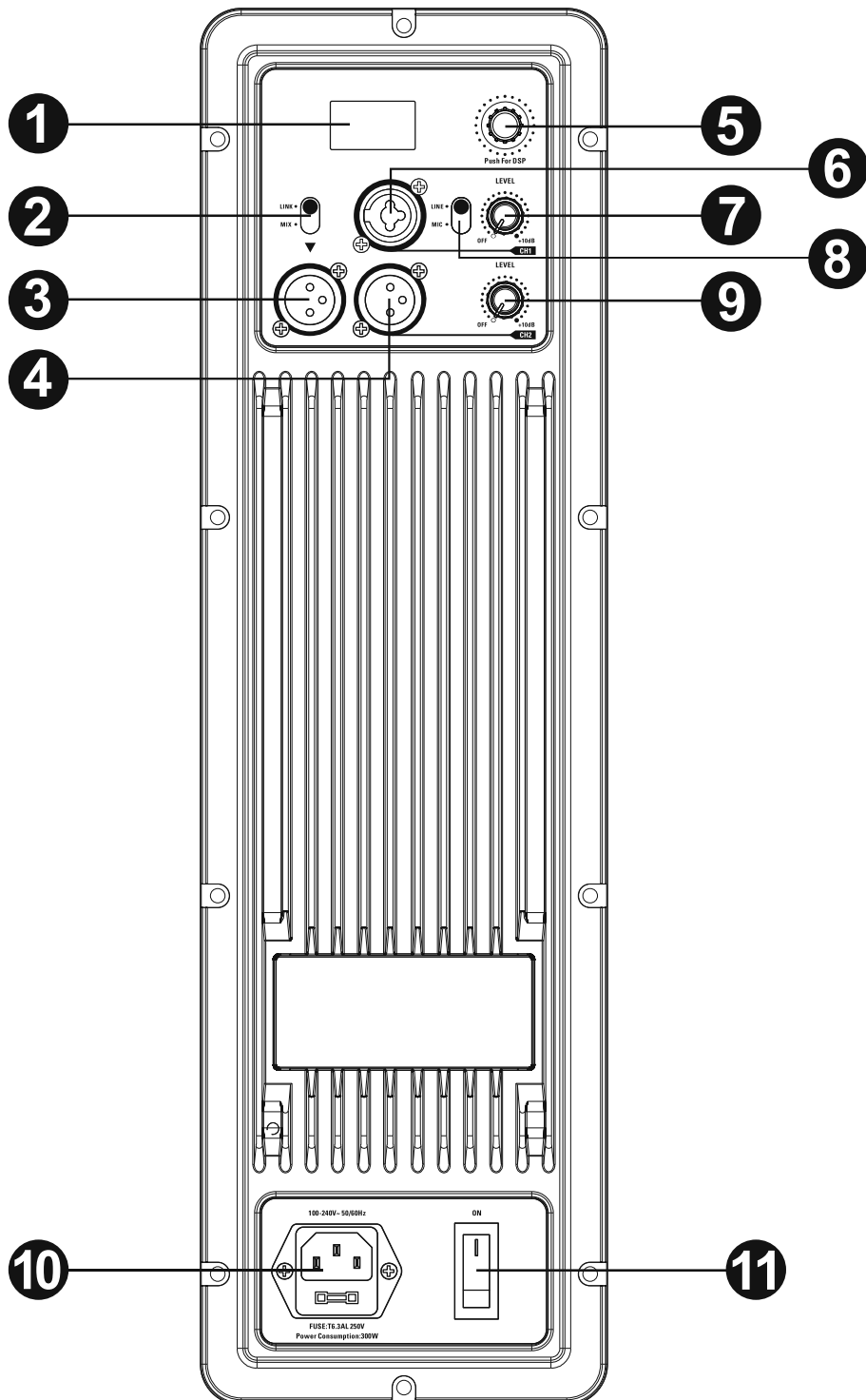

IOS 15A/18A SUB CONTROLS AND FUNCTIONS

PANEL FUNCTIONS INSTRUCTIONS

1. SERVICE DATA:

Only used by Pegasus customer service department. Please do not insert any other USB.

2. LCD DISPLAY

The display shows the current DSP status (current preset, digital signal attenuation, input level) and it is used to access the DSP parameters (see DSP SETTINGS for detailed instructions)

3/4 OUTPUT1/ OUTPUT2 XLR output

The XLR connector can connect it to input of another powered active speaker or amplifier, output signal is controlled by input channel volume or not.

5. DSP Edit button

Push and turn this knob to edit the DSP parameters (see DSP SETTINGS for detailed instruction).

6/7 INPUT1/INPUT2 COMBO XLR-JACK input

This is a female combo connector, which accepts a XLR or JACK plug from almost type of equipment with a balanced or unbalanced inputs.

Note: whenever possible, use always balanced cables.
Unbalanced lines may also be used but may result in noise over long cable runs.

The XLR input is wired as follows:

pin 1=GND

pin 2=+positive or hot

pin 3=-negative or cold

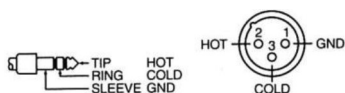

Balanced JACK input is wired as follows:

Tip=+positive or hot

Ring=-negative or cold

Sleeve=GND

PANEL FUNCTIONS INSTRUCTIONS

8. AC socket

Here's where you plug in your speaker's mains supply cord, you should always use the mains cord supplied with the speaker. 100~240V-50/60Hz, T6.3AL/250V fuse.

Be sure your speaker is turned off before you plug the mains supply cord into an electrical outlet.

9. Power switch

Speaker is "ON" when the switch is in the "ON" position.

Note: when you shut down your equipment, turn off the speakers first. When powering up, turn on the speakers last.

TECHNICAL SPECIFICATIONS

	IOS 10A DSP	IOS 12A DSP	IOS 15A DSP	IOS 15A SUB	IOS 18A SUB
Power output	700W	1000W	1000W	1000W	1000W
Frequency Response	60-20K Hz	50-20K Hz	45-20K Hz	38-120 Hz	35-120 Hz
Max output spl	126 dB	128 dB	129 dB	132 dB	133 dB
Input spl	-10 dBV	-10dBV	-10 dBV	-10 dBV	-10 dBV
Inputs	XLR/1/4"*1	XLR/1/4";XLR*1	XLR/1/4" *1 XLR*1	XLR/1/4" *2	XLR/1/4" *2
Outputs	XLR*1	XLR*1	XLR*1	XLR*2	XLR*2
Woofers	10" woofer *1	12" woofer *1	15" woofer *1	15" subwoofer *1	18" subwoofer *1
Driver	1.35" driver *1	1.35" driver *1	1.35" driver *1	/	/
Coverage Pattern(H*V)	90°*60°	90°*60°	90°*60°	/	/
Crossover point	1.9 KHz	1.9 KHz	1.6KHz	/	/
Power input	220-240V/AC, 50/60 Hz	100-240V/AC, 50/60 Hz	100-240V/AC, 50/60 Hz	/	/
Limiter	DSP digital limiting	DSP digital limiting	DSP digital limiting	DSP digital limiting	DSP digital limiting
Cabinet Material	15mm PLY cabinet	15mm PLY cabinet	15mm PLY cabinet	18mm PLY cabinet	18mm PLY cabinet
Color	black	black	black	black	black
Flypoints	M8	M10	M10	/	/
Pole Socket	φ35mm	φ35mm	φ35mm	M20	M20
MEAS (H*W*D)	560*310*325mm	630*360*354 mm	730*440*439 mm	650*445*720 mm	730*510*820 mm
G.W.	15.6 kg	21 kg	26.3 kg	38 kg	48 kg

Installation

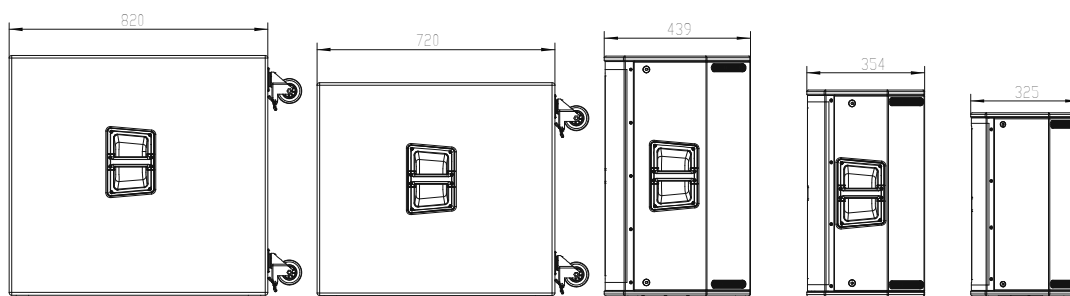
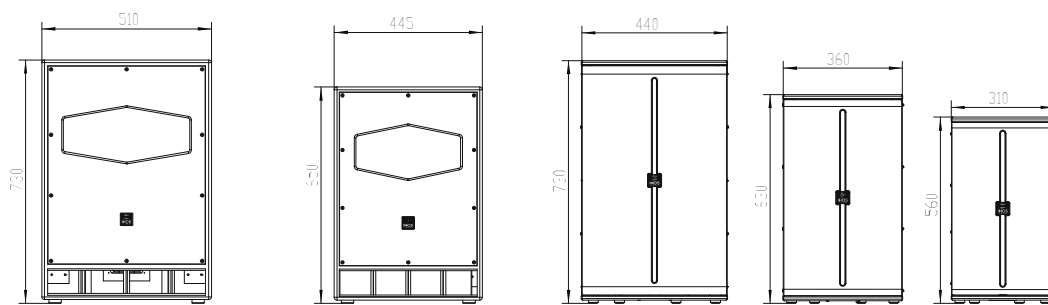



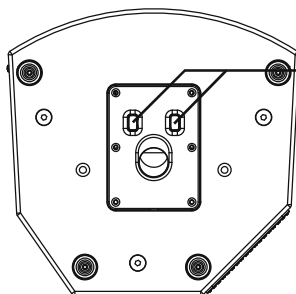
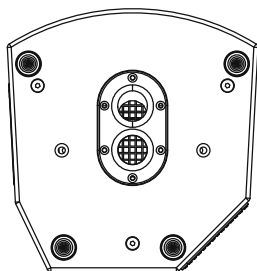
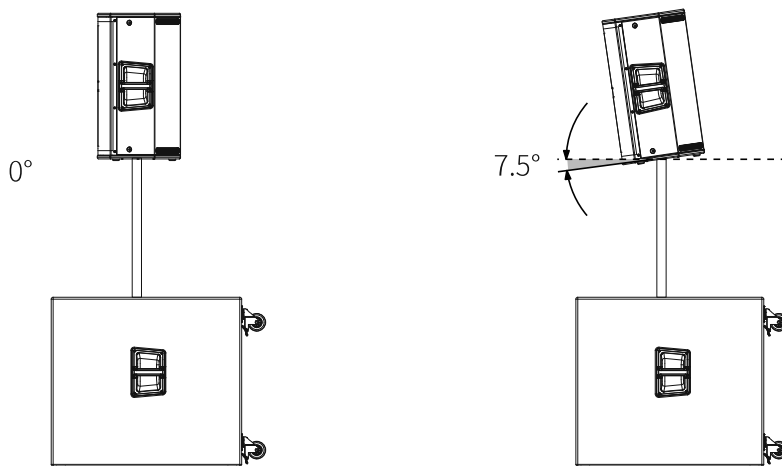













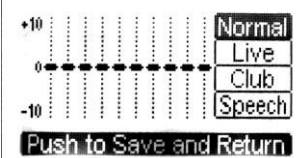













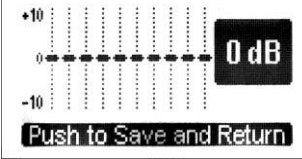





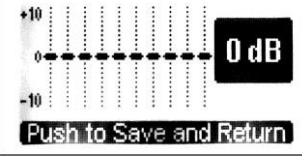









The pitch angle of the cabinet can be 0 degrees or forward 7.5 degrees.

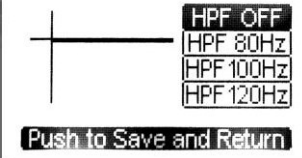



Press 2 buttons at the same time, and then tilt the speaker forward by 7.5 degrees.

When the pitch angle needs to be restored to 0 degrees, press 2 buttons to return.



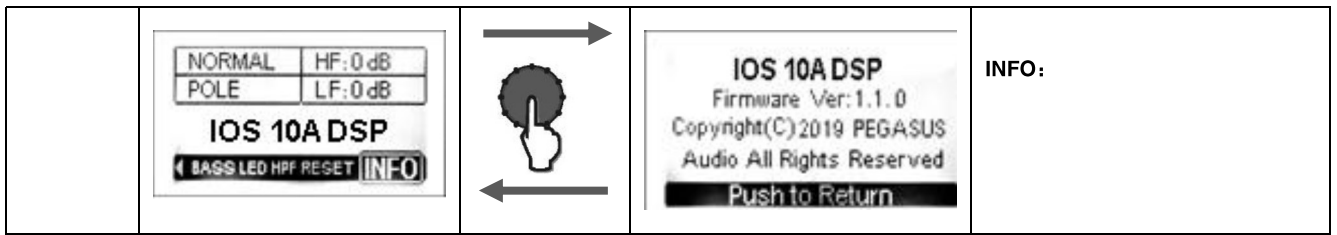







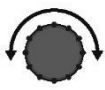

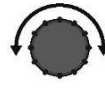

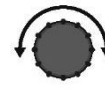
IOS 10A/12A/15A DSP Function Instruction

		IOS 10A DSP	<table border="1" style="width: 100%;"> <tr> <td>MUSIC</td> <td>HF: +10 dB</td> </tr> <tr> <td>MONITOR</td> <td>LF: +10 dB</td> </tr> </table> <p style="text-align: center;">IOS 10A DSP</p> <p style="text-align: center;">[MODE] [LOCATION TREBLE B]</p>	MUSIC	HF: +10 dB	MONITOR	LF: +10 dB						
MUSIC	HF: +10 dB												
MONITOR	LF: +10 dB												
 	<table border="1" style="width: 100%;"> <tr> <td>MUSIC</td> <td>HF: +10 dB</td> </tr> <tr> <td>MONITOR</td> <td>LF: +10 dB</td> </tr> </table> <p style="text-align: center;">IOS 10A DSP</p> <p style="text-align: center;">[MODE] [LOCATION TREBLE B]</p>	MUSIC	HF: +10 dB	MONITOR	LF: +10 dB	  	 <p style="text-align: center;">Push to Save and Return</p>		Mode: Normal Live Club Speech				
MUSIC	HF: +10 dB												
MONITOR	LF: +10 dB												
 	<table border="1" style="width: 100%;"> <tr> <td>NORMAL</td> <td>HF: 0 dB</td> </tr> <tr> <td>POLE</td> <td>LF: 0 dB</td> </tr> </table> <p style="text-align: center;">IOS 10A DSP</p> <p style="text-align: center;">[E] [LOCATION] [TREBLE B]</p>	NORMAL	HF: 0 dB	POLE	LF: 0 dB	  	 <p style="text-align: center;">Push to Save and Return</p>		Location: Pole Monitor Bracket				
NORMAL	HF: 0 dB												
POLE	LF: 0 dB												
 	<table border="1" style="width: 100%;"> <tr> <td>NORMAL</td> <td>HF: 0 dB</td> </tr> <tr> <td>POLE</td> <td>LF: 0 dB</td> </tr> </table> <p style="text-align: center;">IOS 10A DSP</p> <p style="text-align: center;">[LOCATION] [TREBLE] [BASS LEC]</p>	NORMAL	HF: 0 dB	POLE	LF: 0 dB	  	 <p style="text-align: center;">Push to Save and Return</p>		Treble: +10dB ... -10dB				
NORMAL	HF: 0 dB												
POLE	LF: 0 dB												
 	<table border="1" style="width: 100%;"> <tr> <td>NORMAL</td> <td>HF: 0 dB</td> </tr> <tr> <td>POLE</td> <td>LF: 0 dB</td> </tr> </table> <p style="text-align: center;">IOS 10A DSP</p> <p style="text-align: center;">[IN TREBLE] [BASS] [LED HPF I]</p>	NORMAL	HF: 0 dB	POLE	LF: 0 dB	  	 <p style="text-align: center;">Push to Save and Return</p>		Bass: +10dB ... -10dB				
NORMAL	HF: 0 dB												
POLE	LF: 0 dB												
	<table border="1" style="width: 100%;"> <tr> <td>NORMAL</td> <td>HF: 0 dB</td> </tr> <tr> <td>POLE</td> <td>LF: 0 dB</td> </tr> </table> <p style="text-align: center;">IOS 10A DSP</p> <p style="text-align: center;">[TREBLE BASS] [LED] [HPF RES]</p>	NORMAL	HF: 0 dB	POLE	LF: 0 dB	  	<p>Front Panel LED is always "Blue"</p> <table border="1" style="width: 100%;"> <tr> <td>OFF</td> <td>ON</td> </tr> <tr> <td>LIMIT</td> <td></td> </tr> </table> <p style="text-align: center;">Push to Save and Return</p>	OFF	ON	LIMIT			LED: OFF ON LIMIT
NORMAL	HF: 0 dB												
POLE	LF: 0 dB												
OFF	ON												
LIMIT													
 	<table border="1" style="width: 100%;"> <tr> <td>NORMAL</td> <td>HF: 0 dB</td> </tr> <tr> <td>POLE</td> <td>LF: 0 dB</td> </tr> </table> <p style="text-align: center;">IOS 10A DSP</p> <p style="text-align: center;">[TREBLE BASS LED] [HPF] [RES]</p>	NORMAL	HF: 0 dB	POLE	LF: 0 dB	  	 <p style="text-align: center;">Push to Save and Return</p>		X-Over: 150Hz 120Hz 100Hz 80Hz				
NORMAL	HF: 0 dB												
POLE	LF: 0 dB												
 	<table border="1" style="width: 100%;"> <tr> <td>NORMAL</td> <td>HF: 0 dB</td> </tr> <tr> <td>POLE</td> <td>LF: 0 dB</td> </tr> </table> <p style="text-align: center;">IOS 10A DSP</p> <p style="text-align: center;">[FILE BASS LED HPF] [RESET]</p>	NORMAL	HF: 0 dB	POLE	LF: 0 dB	  	<p>Are you sure? Restore the device to the factory default settings</p> <table border="1" style="width: 100%;"> <tr> <td>YES</td> <td>NO</td> </tr> </table> <p style="text-align: center;">Push to Save and Return</p>	YES	NO		Factory settings: YES NO		
NORMAL	HF: 0 dB												
POLE	LF: 0 dB												
YES	NO												

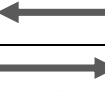

Note:  Press to confirm, and rotate clockwise or counterclockwise to select.

IOS 15A/18A SUB Function Instruction

		<h2 style="margin: 0;">IOS 15A SUB</h2>	<table border="1" style="margin: 0 auto; border-collapse: collapse;"> <tr><td>NORMAL</td><td>60 Hz</td></tr> <tr><td>NORMAL</td><td>0.00 ms</td></tr> <tr><td colspan="2" style="text-align: center;">DXR15S</td></tr> <tr><td colspan="2" style="text-align: center;">+2 dB</td></tr> </table>	NORMAL	60 Hz	NORMAL	0.00 ms	DXR15S		+2 dB													
NORMAL	60 Hz																						
NORMAL	0.00 ms																						
DXR15S																							
+2 dB																							
→	<table border="1" style="margin: 0 auto; border-collapse: collapse;"> <tr><td>NORMAL</td><td>60 Hz</td></tr> <tr><td>NORMAL</td><td>0.00 ms</td></tr> <tr><td colspan="2" style="text-align: center;">IOS 15A SUB</td></tr> <tr><td colspan="2" style="text-align: center;">+2 dB</td></tr> </table>	NORMAL	60 Hz	NORMAL	0.00 ms	IOS 15A SUB		+2 dB			Main volume control interface +10dB ... MUTE												
NORMAL	60 Hz																						
NORMAL	0.00 ms																						
IOS 15A SUB																							
+2 dB																							
↙	<table border="1" style="margin: 0 auto; border-collapse: collapse;"> <tr><td>NORMAL</td><td>60 Hz</td></tr> <tr><td>NORMAL</td><td>0.00 ms</td></tr> <tr><td colspan="2" style="text-align: center;">IOS 15A SUB</td></tr> <tr><td colspan="2" style="text-align: center;">MODE LOCATION DELAY</td></tr> </table>	NORMAL	60 Hz	NORMAL	0.00 ms	IOS 15A SUB		MODE LOCATION DELAY			<table border="1" style="margin: 0 auto; border-collapse: collapse;"> <tr><td>+10</td><td>Normal</td></tr> <tr><td>0</td><td>Enforce</td></tr> <tr><td>-10</td><td></td></tr> <tr><td colspan="2" style="text-align: center;">Push to Save and Return</td></tr> </table>	+10	Normal	0	Enforce	-10		Push to Save and Return			Mode: Normal Enforce		
NORMAL	60 Hz																						
NORMAL	0.00 ms																						
IOS 15A SUB																							
MODE LOCATION DELAY																							
+10	Normal																						
0	Enforce																						
-10																							
Push to Save and Return																							
↙	<table border="1" style="margin: 0 auto; border-collapse: collapse;"> <tr><td>NORMAL</td><td>60 Hz</td></tr> <tr><td>NORMAL</td><td>0.00 ms</td></tr> <tr><td colspan="2" style="text-align: center;">IOS 15A SUB</td></tr> <tr><td colspan="2" style="text-align: center;">MODE LOCATION DELAY</td></tr> </table>	NORMAL	60 Hz	NORMAL	0.00 ms	IOS 15A SUB		MODE LOCATION DELAY			<table border="1" style="margin: 0 auto; border-collapse: collapse;"> <tr><td>Normal</td></tr> <tr><td>Cardioid</td></tr> <tr><td>Endfire</td></tr> <tr><td colspan="2" style="text-align: center;">Push to Save and Return</td></tr> </table>	Normal	Cardioid	Endfire	Push to Save and Return			Location: Normal Cardioid Endfire					
NORMAL	60 Hz																						
NORMAL	0.00 ms																						
IOS 15A SUB																							
MODE LOCATION DELAY																							
Normal																							
Cardioid																							
Endfire																							
Push to Save and Return																							
↙	<table border="1" style="margin: 0 auto; border-collapse: collapse;"> <tr><td>NORMAL</td><td>60 Hz</td></tr> <tr><td>NORMAL</td><td>0.00 ms</td></tr> <tr><td colspan="2" style="text-align: center;">IOS 15A SUB</td></tr> <tr><td colspan="2" style="text-align: center;">MODE LOCATION DELAY POLARITY</td></tr> </table>	NORMAL	60 Hz	NORMAL	0.00 ms	IOS 15A SUB		MODE LOCATION DELAY POLARITY			<table border="1" style="margin: 0 auto; border-collapse: collapse;"> <tr><td>0.00</td><td>ms</td></tr> <tr><td>0.00</td><td>meter</td></tr> <tr><td>0.00</td><td>feet</td></tr> <tr><td colspan="2" style="text-align: center;">Push to Save and Return</td></tr> </table>	0.00	ms	0.00	meter	0.00	feet	Push to Save and Return			Delay: NONE ... 10.5m / NONE ... 34ft		
NORMAL	60 Hz																						
NORMAL	0.00 ms																						
IOS 15A SUB																							
MODE LOCATION DELAY POLARITY																							
0.00	ms																						
0.00	meter																						
0.00	feet																						
Push to Save and Return																							
↙	<table border="1" style="margin: 0 auto; border-collapse: collapse;"> <tr><td>NORMAL</td><td>60 Hz</td></tr> <tr><td>NORMAL</td><td>0.00 ms</td></tr> <tr><td colspan="2" style="text-align: center;">IOS 15A SUB</td></tr> <tr><td colspan="2" style="text-align: center;">MODE LOCATION DELAY POLARITY</td></tr> </table>	NORMAL	60 Hz	NORMAL	0.00 ms	IOS 15A SUB		MODE LOCATION DELAY POLARITY			<table border="1" style="margin: 0 auto; border-collapse: collapse;"> <tr><td>Normal</td></tr> <tr><td>Reverse</td></tr> <tr><td colspan="2" style="text-align: center;">Push to Save and Return</td></tr> </table>	Normal	Reverse	Push to Save and Return			Polarity: Normal Reverse						
NORMAL	60 Hz																						
NORMAL	0.00 ms																						
IOS 15A SUB																							
MODE LOCATION DELAY POLARITY																							
Normal																							
Reverse																							
Push to Save and Return																							
↙	<table border="1" style="margin: 0 auto; border-collapse: collapse;"> <tr><td>NORMAL</td><td>60 Hz</td></tr> <tr><td>NORMAL</td><td>0.00 ms</td></tr> <tr><td colspan="2" style="text-align: center;">IOS 15A SUB</td></tr> <tr><td colspan="2" style="text-align: center;">MODE LOCATION DELAY POLARITY</td></tr> </table>	NORMAL	60 Hz	NORMAL	0.00 ms	IOS 15A SUB		MODE LOCATION DELAY POLARITY			<table border="1" style="margin: 0 auto; border-collapse: collapse;"> <tr><td>60 Hz</td></tr> <tr><td colspan="2" style="text-align: center;">Push to Save and Return</td></tr> </table>	60 Hz	Push to Save and Return			X-Over: 150Hz 120Hz 100Hz 80Hz 60Hz							
NORMAL	60 Hz																						
NORMAL	0.00 ms																						
IOS 15A SUB																							
MODE LOCATION DELAY POLARITY																							
60 Hz																							
Push to Save and Return																							
↙	<table border="1" style="margin: 0 auto; border-collapse: collapse;"> <tr><td>NORMAL</td><td>60 Hz</td></tr> <tr><td>NORMAL</td><td>0.00 ms</td></tr> <tr><td colspan="2" style="text-align: center;">IOS 15A SUB</td></tr> <tr><td colspan="2" style="text-align: center;">MODE LOCATION DELAY POLARITY</td></tr> </table>	NORMAL	60 Hz	NORMAL	0.00 ms	IOS 15A SUB		MODE LOCATION DELAY POLARITY			<table border="1" style="margin: 0 auto; border-collapse: collapse;"> <tr><td>Are you sure?</td></tr> <tr><td>Restore the device to the factory default settings</td></tr> <tr><td style="text-align: right;">YES NO</td></tr> <tr><td colspan="2" style="text-align: center;">Push to Save and Return</td></tr> </table>	Are you sure?	Restore the device to the factory default settings	YES NO	Push to Save and Return			Factory settings: YES NO					
NORMAL	60 Hz																						
NORMAL	0.00 ms																						
IOS 15A SUB																							
MODE LOCATION DELAY POLARITY																							
Are you sure?																							
Restore the device to the factory default settings																							
YES NO																							
Push to Save and Return																							
↙	<table border="1" style="margin: 0 auto; border-collapse: collapse;"> <tr><td>NORMAL</td><td>150 Hz</td></tr> <tr><td>NORMAL</td><td>0.00 ms</td></tr> <tr><td colspan="2" style="text-align: center;">IOS 15A SUB</td></tr> <tr><td colspan="2" style="text-align: center;">MODE LOCATION DELAY POLARITY</td></tr> </table>	NORMAL	150 Hz	NORMAL	0.00 ms	IOS 15A SUB		MODE LOCATION DELAY POLARITY			<table border="1" style="margin: 0 auto; border-collapse: collapse;"> <tr><td colspan="2" style="text-align: center;">IOS 15A SUB</td></tr> <tr><td colspan="2" style="text-align: center;">Firmware Ver: 1.1.0</td></tr> <tr><td colspan="2" style="text-align: center;">Copyright(C)2019 PEGASUS</td></tr> <tr><td colspan="2" style="text-align: center;">Audio All Rights Reserved</td></tr> <tr><td colspan="2" style="text-align: center;">Push to Return</td></tr> </table>	IOS 15A SUB		Firmware Ver: 1.1.0		Copyright(C)2019 PEGASUS		Audio All Rights Reserved		Push to Return			
NORMAL	150 Hz																						
NORMAL	0.00 ms																						
IOS 15A SUB																							
MODE LOCATION DELAY POLARITY																							
IOS 15A SUB																							
Firmware Ver: 1.1.0																							
Copyright(C)2019 PEGASUS																							
Audio All Rights Reserved																							
Push to Return																							
↙	<table border="1" style="margin: 0 auto; border-collapse: collapse;"> <tr><td>NORMAL</td><td>60 Hz</td></tr> <tr><td>NORMAL</td><td>0.00 ms</td></tr> <tr><td colspan="2" style="text-align: center;">IOS 15A SUB</td></tr> <tr><td colspan="2" style="text-align: center;">MODE LOCATION DELAY</td></tr> </table>	NORMAL	60 Hz	NORMAL	0.00 ms	IOS 15A SUB		MODE LOCATION DELAY			<table border="1" style="margin: 0 auto; border-collapse: collapse;"> <tr><td>NORMAL</td><td>60 Hz</td></tr> <tr><td>NORMAL</td><td>0.00 ms</td></tr> <tr><td colspan="2" style="text-align: center;">IOS 15A SUB</td></tr> <tr><td colspan="2" style="text-align: center;">+2 dB</td></tr> </table>	NORMAL	60 Hz	NORMAL	0.00 ms	IOS 15A SUB		+2 dB			Exit		
NORMAL	60 Hz																						
NORMAL	0.00 ms																						
IOS 15A SUB																							
MODE LOCATION DELAY																							
NORMAL	60 Hz																						
NORMAL	0.00 ms																						
IOS 15A SUB																							
+2 dB																							

Note:  Press to confirm, and rotate clockwise or counterclockwise to select.

SUPPORT AND TROUBLESHOOTING

TROUBLESHOOTING	
No sound from the loudspeaker	<p>A. Make sure the power cord is fully and securely inserted in the IEC receptacle and in the outlet. And the loudspeaker is on.</p> <p>B. Make sure the right connection of all cables. And check if the unit is linked with a device by Bluetooth.</p> <p>C. Make sure the volume is an appropriate level.</p>
Loudspeaker has hum or buzz	<p>A. Check the input sources.</p> <p>B. Turn off the Mic and adjust the Mic volume to minimum.</p> <p>C. Make sure all the cables are connected properly.</p>
No sound or low volume from the Microphone	<p>A. Make sure switch on the Microphone.</p> <p>B. Check if switching the input source to Mic.</p> <p>C. Adjust the Mic volume to a appropriate level.</p>
Screaming, noise, distorted sound from the Mic	<p>A. Check to adjust the microphone volume and reverb to a appropriate level.</p> <p>B. Adjust the distance between the microphone and loudspeaker. Must not point to the microphone to loudspeaker directly.</p> <p>C. Check if the TONE is set too high, and try to turn it off.</p>
Sound breaks up intermittently or sound distorts	<p>A. The input level might be too high. (Avoid the LIMIT warning in the LCD screen)</p> <p>B. Check the Channel switch.(When using the line-in, do not switch to Mic)</p>
Only one satellite speaker has sound	<p>A. Make sure to link the satellite by TS cable</p> <p>B. Make sure the SETUP is switched to 2.1 mode.</p>
Bluetooth can not work	<p>A. Check if switching the input source to Bluetooth.</p> <p>B. Try to adjust the volume of MASTER to an appropriate level.</p>

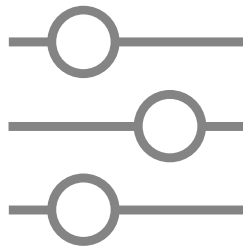

IHOS
INTELLIGENT AUDIO

www.i-hos.eu
sales@i-hos.eu